



2029A

NPN Epitaxial Planar Silicon Composite Transistor

T-29-27

Differential Amp Applications

©958B

Applications

- . Differential amp, current mirror, temperature compensator.

Features

- . Excellent in thermal equilibrium and suited for use in differential amp applications.
- . Matched pair capability.

Absolute Maximum Ratings at Ta=25°C

Parameter	Symbol	Value	unit
Collector to Base Voltage	V _{CB0}	55	V
Collector to Emitter Voltage	V _{CEO}	50	V
Emitter to Base Current	V _{EBO}	5	V
Collector Current	I _C	150	mA
Peak Collector Current	i _{cp}	300	mA
Collector Dissipation	P _C	200	mW
Total Dissipation	P _T	400	mW
Junction Temperature	T _J	150	°C
Storage Temperature	T _{stg}	-55 to +150	°C

Electrical Characteristics at Ta=25°C

Parameter	Symbol	Test Conditions	min	typ	max	unit
Collector Cutoff Current	I _{CBO}	V _{CB} =35V, I _E =0			0.1	uA
Emitter Cutoff Current	I _{EBO}	V _{EB} =4V, I _C =0			0.1	uA
DC Current Gain	h _{FE}	V _{CE} =6V, I _C =1mA	100*		960*	
DC Current Gain Ratio	h _{FE(small/large)}	V _{CE} =6V, I _C =1mA	0.85	0.98		
Base to Emitter Voltage Drop	V _{BE(large-small)}	V _{CE} =6V, I _C =1mA	1.0		10	mV
Collector to Emitter Saturation Voltage	V _{CE(sat)}	I _C =50mA, I _B =5mA			0.5	V
Gain-Bandwidth Product	f _T	V _{CE} =6V, I _C =1mA		100		MHz
Output Capacitance	c _{ob}	V _{CB} =10V, f=1MHz		2.5		pF

Continued on next page.

*The 2SC3064 is classified by h_{FE(small)} as follows:

100 E 200	160 F 320	280 G 560	480 H 960
-----------	-----------	-----------	-----------

Case Outline 2029A

(unit:mm)

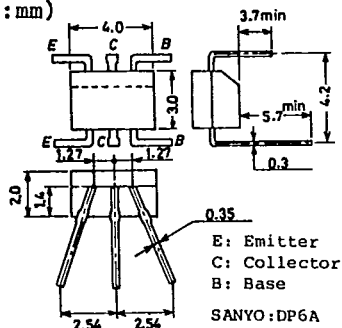

The 2SC3064 is provided with a surface mounted package.

Case Outline 2030A

(unit:mm)

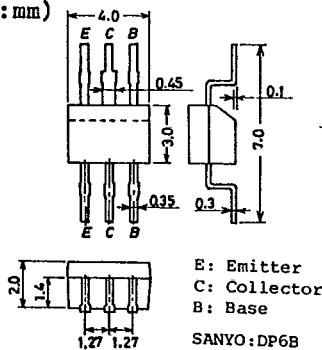

Continued from preceding page.

			min	typ	max	unit
Collector to Base Breakdown Voltage	$V_{(BR)CBO}$	$I_C=10\mu A, I_E=0$	55			V
Collector to Emitter Breakdown Voltage	$V_{(BR)CEO}$	$I_C=1mA, R_{BE}=\infty$	50			V
Emitter to Base Breakdown Voltage	$V_{(BR)EBO}$	$I_E=10\mu A, I_C=0$	5			V

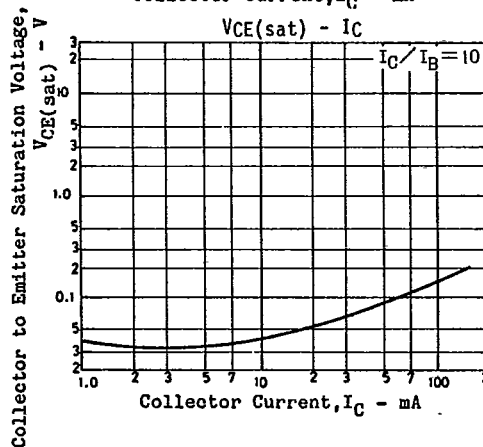
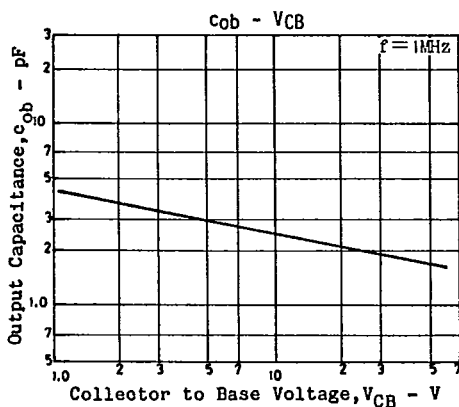
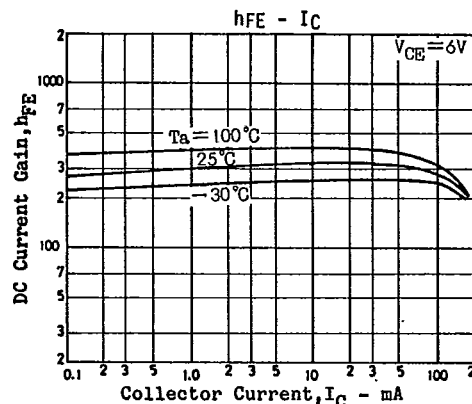
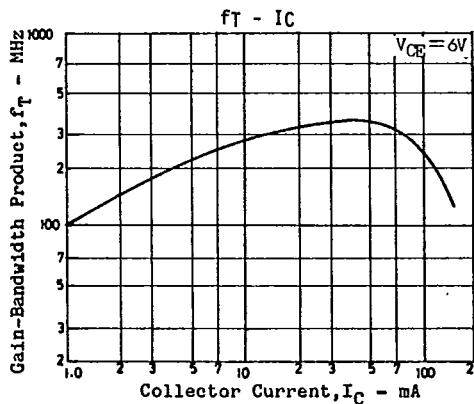
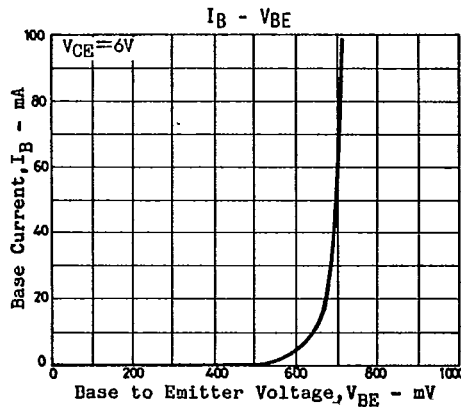
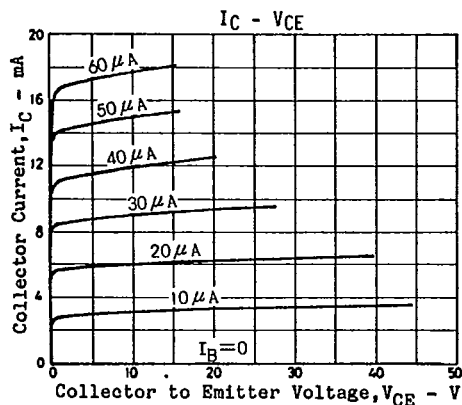

25C3064

T-29-27

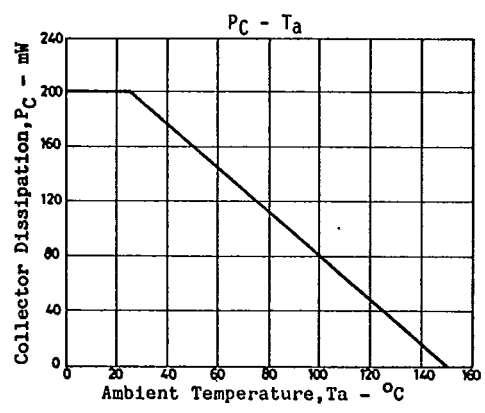

T-91-20

CASE OUTLINES OF LEAD FORMED SMALL SIGNAL TRANSISTORS

- All of Sanyo lead formed small signal transistor case outlines are illustrated below.
- All dimensions are in mm, and dimensions which are not followed by min. or max. are represented by typical values.
- No marking is indicated.

Case Outline-[2003A] unit: mm

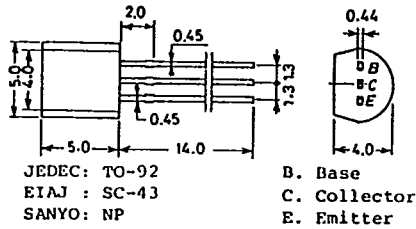

Case Outline-[2019A] unit: mm

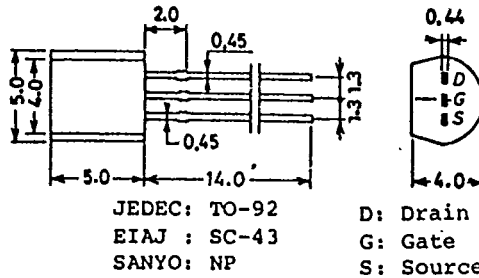

Case Outline-[2004A] unit: mm

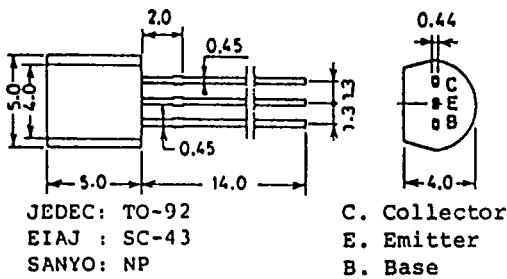

Case Outline-[2025] unit: mm

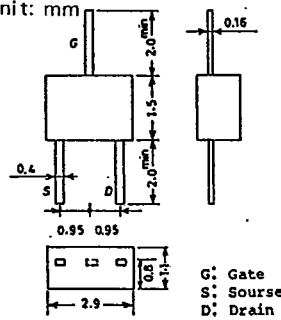

Case Outline-[2005A] unit: mm

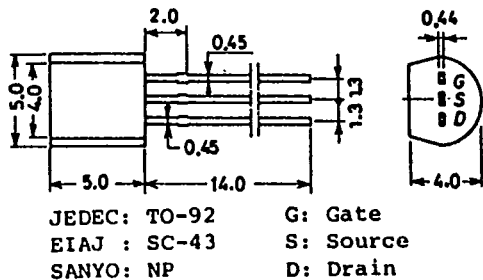

Case Outline-[2026] unit: mm

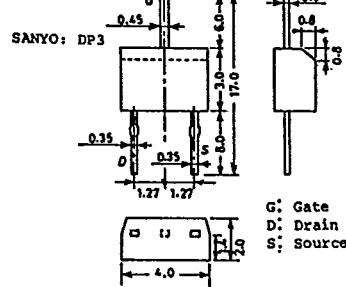

Case Outline-[2006A] unit: mm

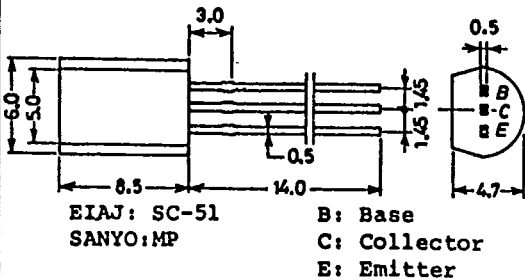

Case Outline-[2027A] unit: mm

